

GRU A TORRE

GA 130

GRU AUTOMATICA CON
MONTAGGIO IDRAULICO

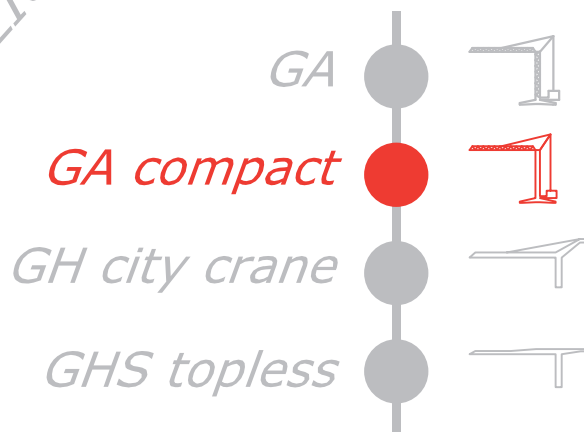

FB F.lli Butti s.r.l.

Via XXV Aprile, 58

23868 Valmadrera (LC) - ITALIA

Tel. 0341.581108 - Fax 0341.200253

E-mail : fbgru@fbgru.it - <http://www.fbgru.it>



GA 130 braccio m 30 flecha — jib
ausleger — fleche

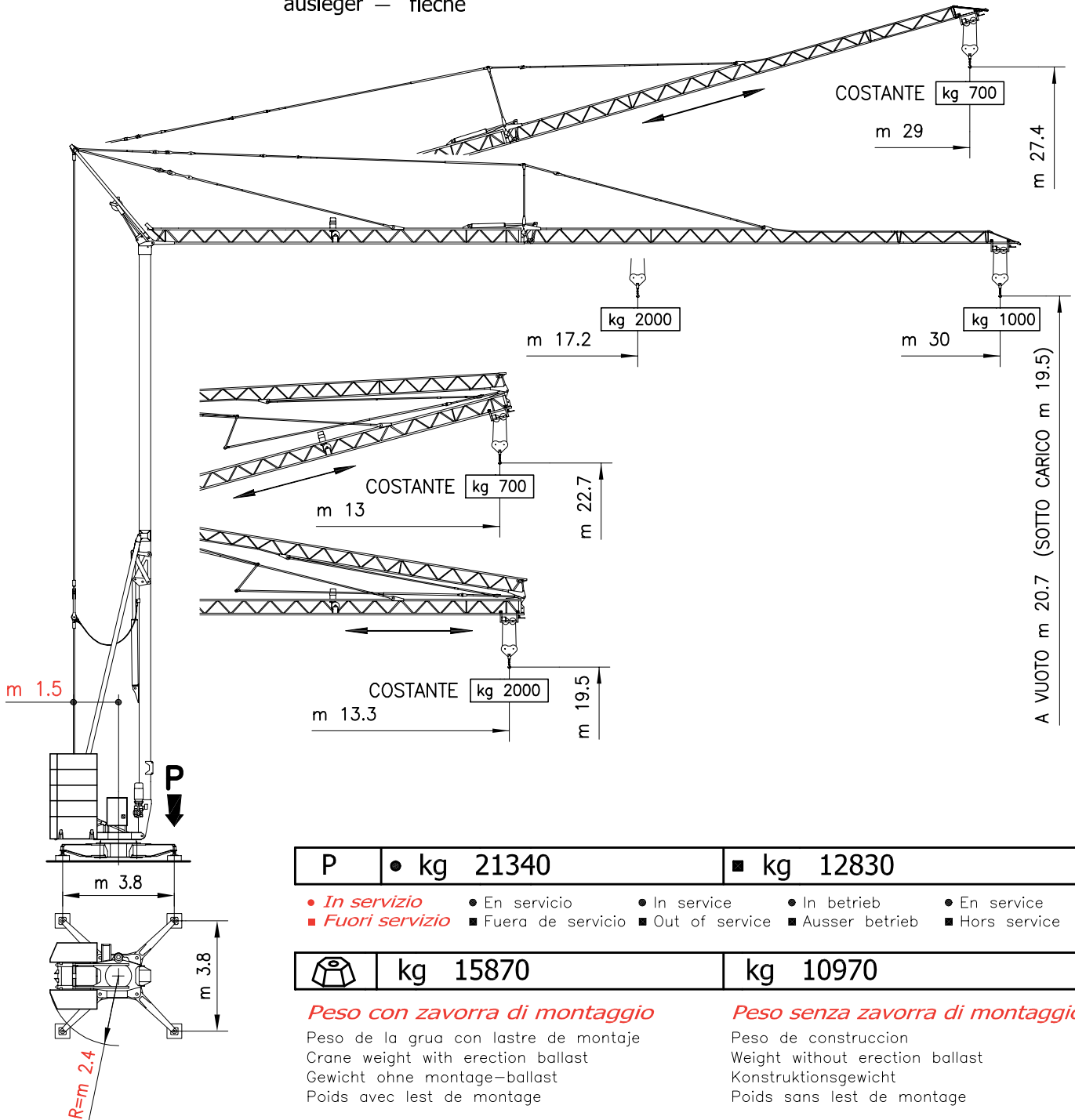

GA 130 braccio m 27 flecha — jib
ausleger — fleche

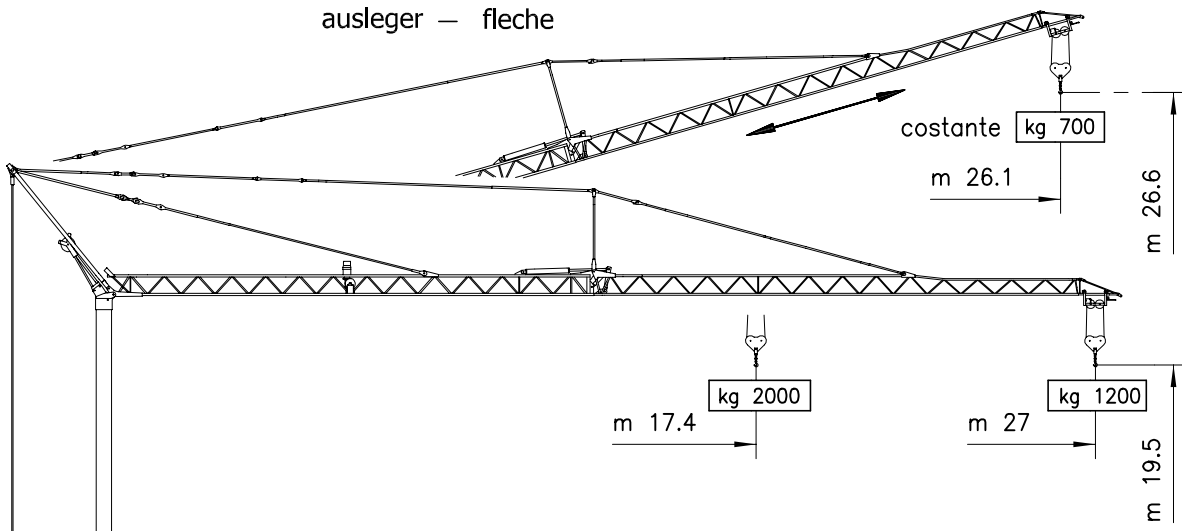



MECCANISMI

MECANISMOS – MECHANISMS
ANTRIEBE – MÉCANISMES

MOVIMENTO MOVIMIENTO MOVEMENT BEWEGUNG MOUVEMENT	ALIMENTAZIONE ALIMENTACION OPERATING VOLTAGE BETRIEBSSPANNUNG TENSION DE SERVICE	PRESTAZIONI FUNCIONAMIENTOS PERFORMANCES LEISTUNGEN EXÉCUTIONS	POTENZA NECESSARIA POTENCIA NECESARIA POWER REQUIREMENT KRAFTE DARF PUISSANCE NÉCESSAIRE
---	---	---	---

		▷ m/1' - kg	▷▷ m/1' - kg	▷▷▷ m/1' - kg	
SOLLEVAMENTO ELEVACION – HOISTING HEBEN – LEVAGE 	400 V 50 Hz	5 ↑↓	26 ↑ 27 ↓	40 ↑ 42 ↓	kW 9.2
INVERTER		2000	2000	1000	

		▷ m/1'	▷▷ m/1'	
CARRELLO CARRILLO – JIB TROLLEY LAUFKATZE – DISTRIBUTION 	400 V 50 Hz	15	40	kW 2.2
INVERTER				

		▷ m/1'	▷▷ m/1'	
ROTAZIONE ROTACION – SLEWING DREHEN – ORIENTATION 	400 V 50 Hz	0 → 0.2	0.2 → 0.85	kW 2.2
INVERTER				



Conforme alle direttive
CEE sul livello acustico
2000/14/CE

Conforme con las directivas
CEE sobre el nivel acustico

In compliance with the EEC
instructions on noise levell

Gemass EWG-Richtlinien für
den Schall-Leistungspegel

Conforme aux directives CEE
sur le niveau acoustique

CURVE DI CARICO

CURVAS DE CARGAS – LOAD DIAGRAMS
LASTKURVEN – COURBES DE CHARGES

m	17.2	17.4	18	19	20	21	22	23	24	25	26	27	28	29	30
kg	2000	1940	1896	1780	1678	1585	1501	1425	1356	1292	1234	1180	1130	1083	1000
		2000	1927	1810	1705	1611	1527	1449	1379	1315	1255	1200			

BRACCIO IMPENNATO FLECHA IZADA LUFFING JIB AUSLEGER IN STEILSTELLUNG FLÈCHE RELEVÉE	↔	Carrellino distributore Carrellino distribuidor – Traversing trolley Verfahrbare laufkatze – Chariot distributeur	kg 700
--	---	--	--------

POTENZA RICHIESTA

POTENCIA-ELECTRICA NECESARIA – NECESSARY ELECTRIC POWER
KRAFTBEDARF – PUISSANCE ELECTRIQUE NECESSAIRE

ALIMENTAZIONE TRIFASE TRIFASICA THREE PHASE DREIPHASIGE TRIPHASE	12 kw 400 V - 50 Hz	SOLLEVAMENTO ELEVACION HOISTING HEBEN LEVAGE	kg 2000
---	------------------------	---	---------

Con riserva di modifiche

Derecho de modificaciones reservadas

Subject to change without notice

Anderungen vorbehalten

Modifications réservées

MONTAGGIO MONTAJE — ERECTION
MONTAGE — MONTAGE

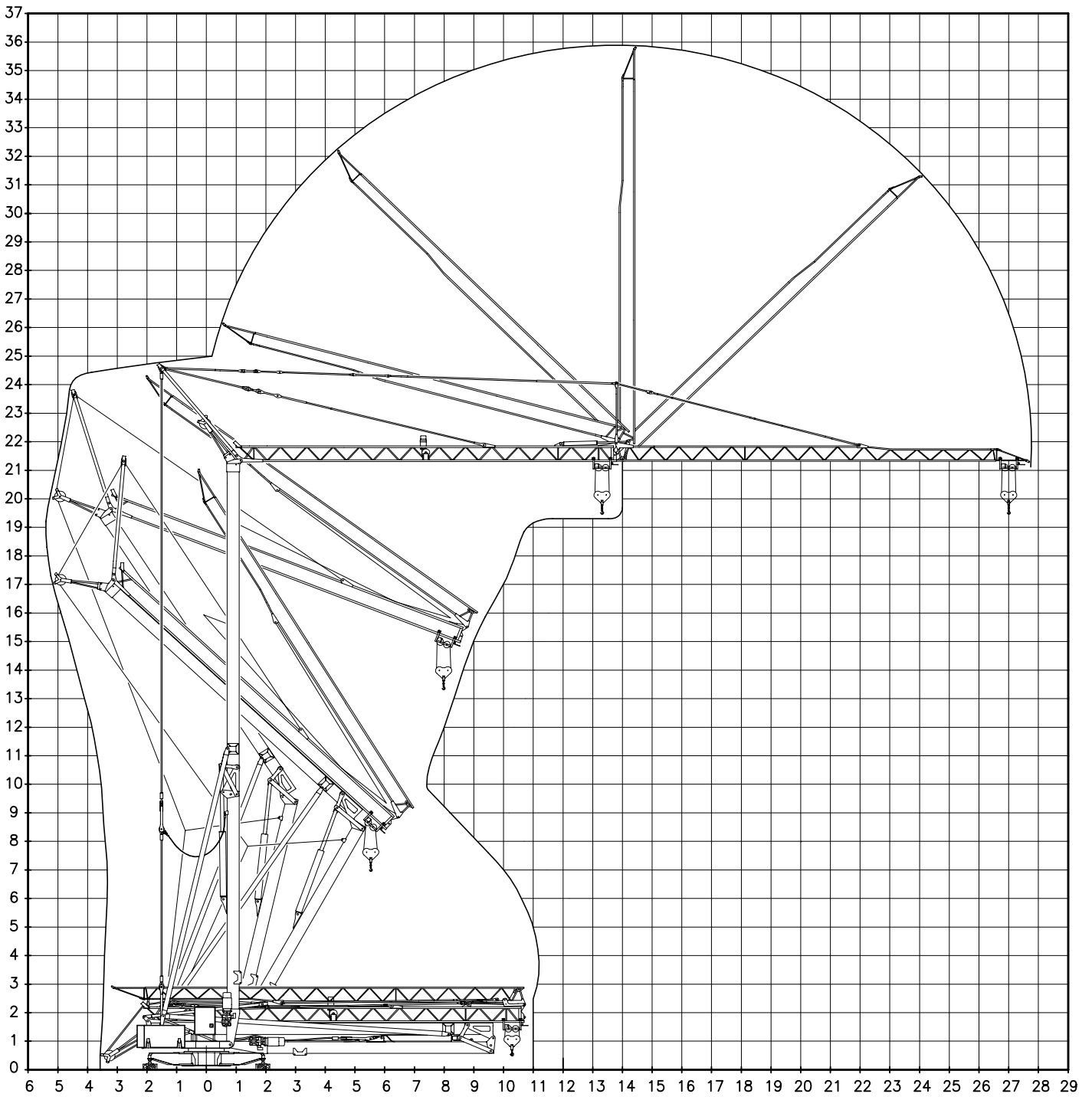

TRASPORTO TRANSPORTE — TRANSPORT
TRANSPORT — TRANSPORT

